

# Product Information

## FIDENLEA-AD - Adventure Learning Den

BS EN 1176 - Designed to British & European Standards

### MATERIALS

**Panels** - Two Colour  High Density Polyethylene (HDPE)

**Posts** - Extruded aluminium post with powder coat finish

### SUPPLY METHOD

Pre-assembled items: Roof, Benches, Panels, Mini Posts

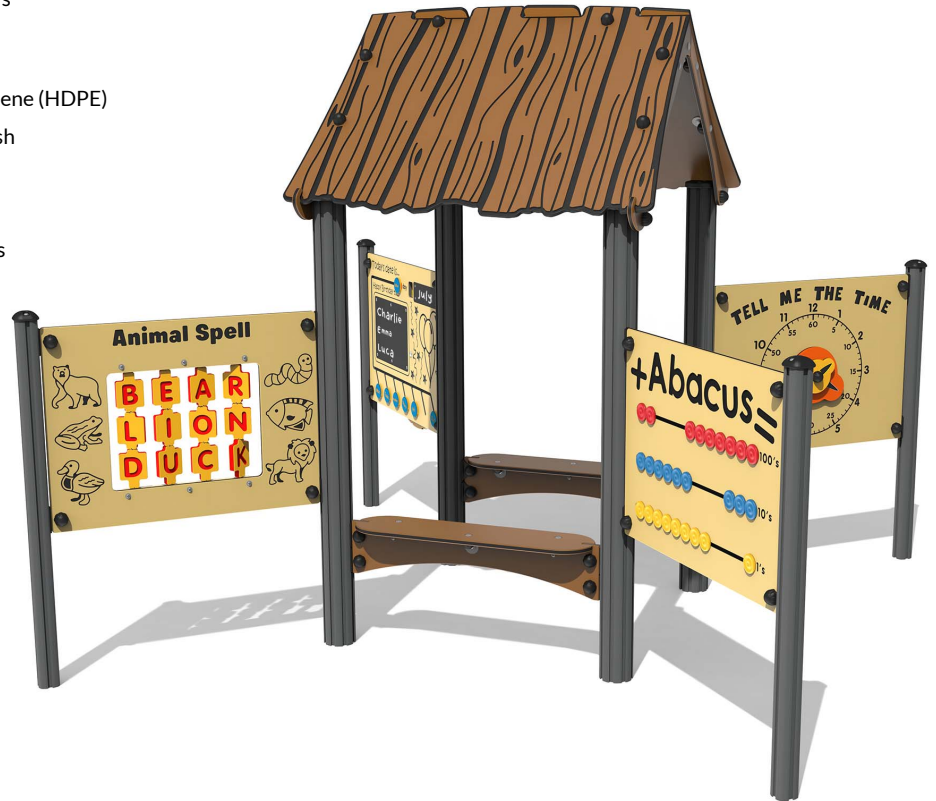

### DIMENSIONS

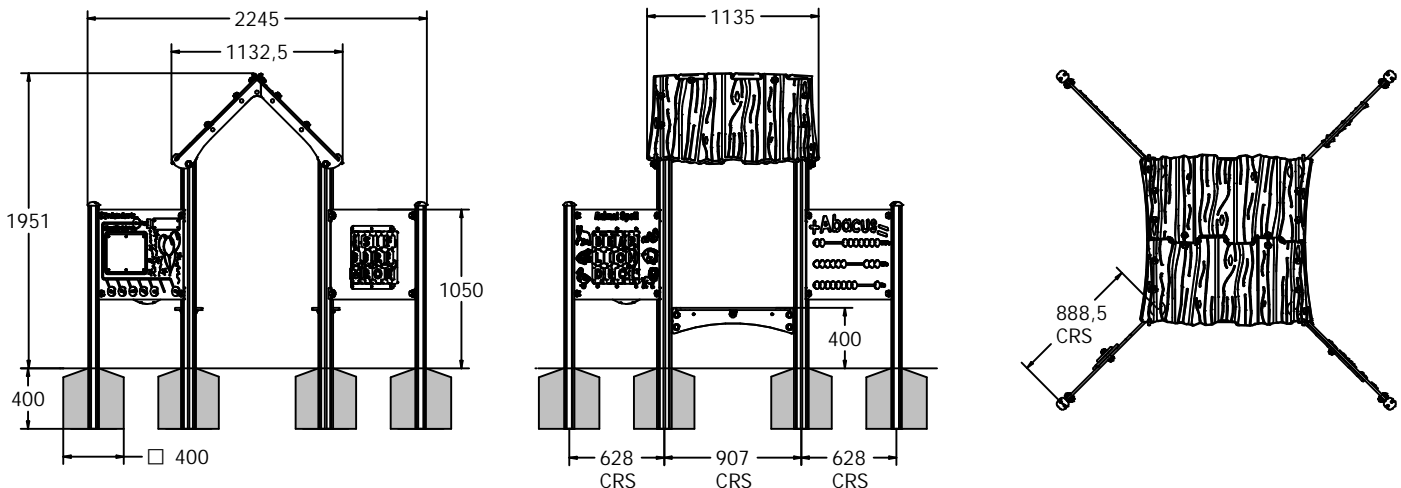

### TECHNICAL

**Age Range:** 2+ Years  
**Largest Part:** Tall Aluminium Post: 100 x 100 x 1785mm  
**Heaviest Part:** Adventure Apex Roof Half - 13.2kg  
**Total Weight:** 99kg Approx.  
**Surfacing:** N/A

IMPORTANT: you must specify the colour option you require at the time of order if it is different from the colour listed/shown above, requirements are subject to availability at the time of order

## Product Information

### FIDENLEA-AD - Adventure Learning Den

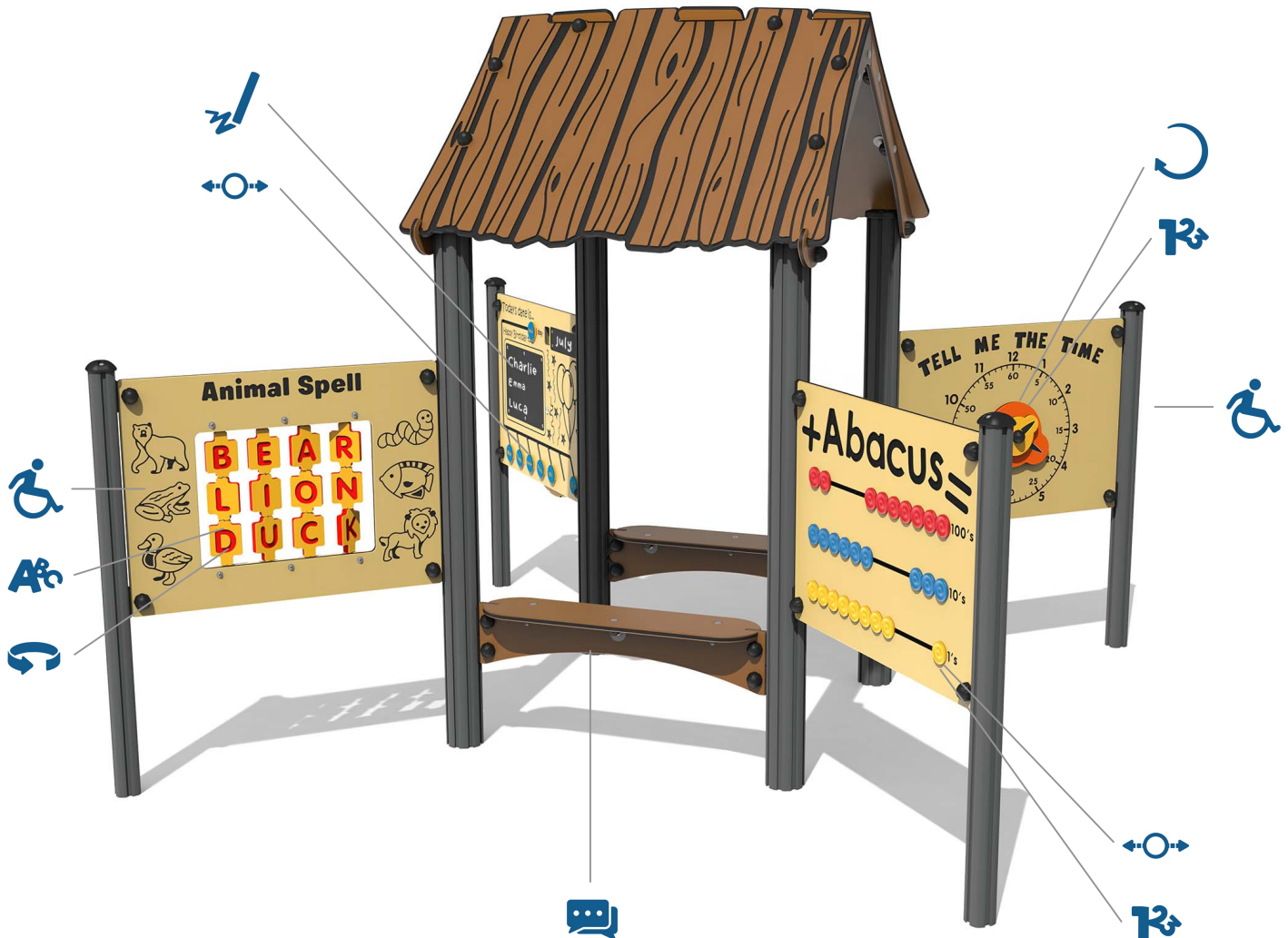

#### FEATURES

 **COUNTERS** - Abacus and today's date counters

 **FLIP** - 12 Flip over letter spinners

 **ROTATE** - 360° turn Clock hands

 **INCLUSIVE** - Panels positioned at easily accessible heights

 **DRAW** - Chalkboard activity

 **SOCIAL** - Seating encourages interaction between children

 **LETTERS** - Animal spelling activity

 **NUMBERS** - Develops Counting skills and telling the time

IMPORTANT: you must specify the colour option you require at the time of order if it is different from the colour listed/shown above, requirements are subject to availability at the time of order