

# Product Information

## FIDENGAM-AD - Adventure Games Den

BS EN 1176 - Designed to British & European Standards

### MATERIALS

**Panels** - Two Colour  High Density Polyethylene (HDPE)

**Posts** - Extruded aluminium post with powder coat finish

### SUPPLY METHOD

Pre-assembled items: Roof, Benches, Panels, Mini Posts



### DIMENSIONS

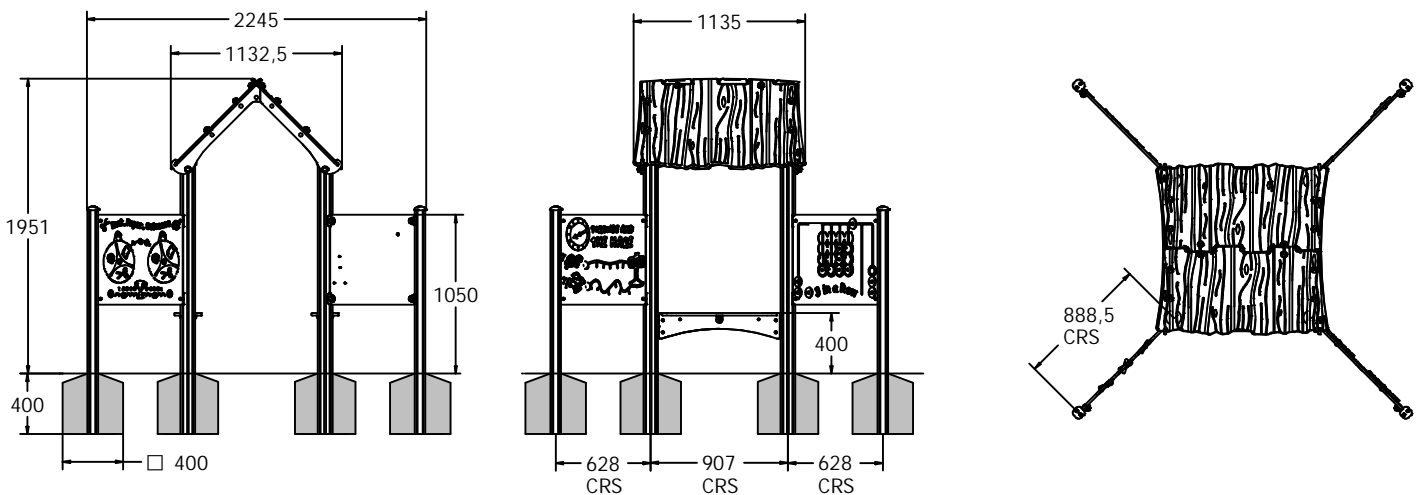

### TECHNICAL

<b>Age Range:</b>	2+ Years
<b>Largest Part:</b>	Tall Aluminium Post: 100 x 100 x 1785mm
<b>Heaviest Part:</b>	Adventure Apex Roof Half - 13.2kg
<b>Total Weight:</b>	97kg Approx.
<b>Surfacing:</b>	N/A







IMPORTANT: you must specify the colour option you require at the time of order if it is different from the colour listed/shown above, requirements are subject to availability at the time of order

# Product Information

## FIDENGAM-AD - Adventure Games Den



### FEATURES

-  **SLIDERS** - Counters used to keep score, and play race game
-  **ROTATE** - Rock, Paper, Scissors and Tortoise and Hare spinners
-  **FLIP** - Noughts and Crosses flip over discs
-  **COUNTER DROP** - 3-in-a-row counters
-  **INCLUSIVE** - Panels positioned at easily accessible heights
-  **SOCIAL** - Seating and Games encourage interaction

IMPORTANT: you must specify the colour option you require at the time of order if it is different from the colour listed/shown above, requirements are subject to availability at the time of order