

# Product Information

## FIEXPENG - Steam Express Train Engine

BS EN 1176 - Designed to British & European Standards

### MATERIALS

**Panels** - Two Colour High Density Polyethylene (HDPE)

**Recycled Profile** - Recycled plastic with textured finish

**LumbeRock Benches** - Recycled HDPE milk bottles with a wood grain finish

### SUPPLY METHOD

Steam Express - Fully assembled

### FEATURES

 **SOCIAL** - Encourages Imaginative Play

 **TUNNEL** - Crawl Thru Tunnel

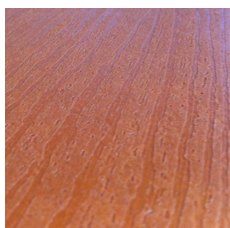

LumbeRock Benches

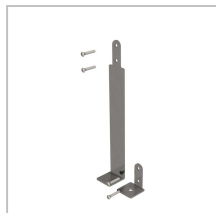

Surface & below ground fixings sold separately

### DIMENSIONS

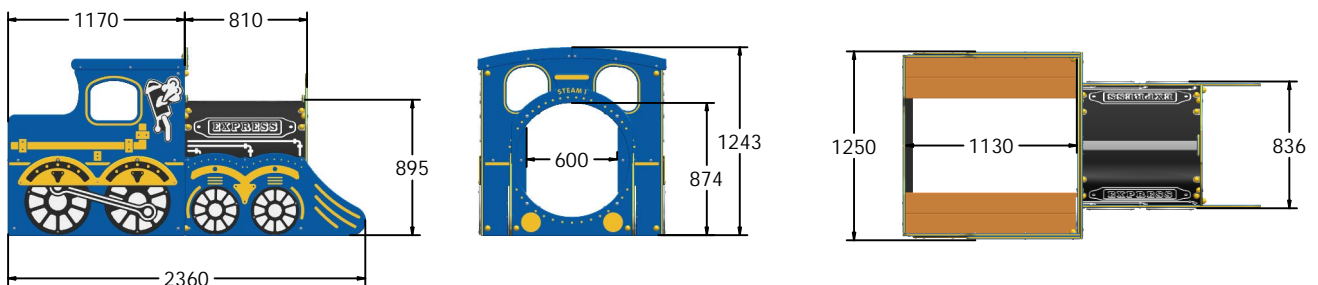

### TECHNICAL

**Age Range:** 2+ Years  
**Largest Part:** FIEXPENG - 2360 x 1243 x 1250mm  
**Total Weight:** FIEXPENG - 153kg  
**Surfacing:** 1.5m from the extents of the equipment with a critical fall height in excess of 895mm

IMPORTANT: you must specify the colour option you require at the time of order if it is different from the colour listed/shown above, requirements are subject to availability at the time of order

# Product Information

## FIEXPCARR - Steam Express Train Carriage

BS EN 1176 - Designed to British & European Standards

### MATERIALS

**Panels** - Two Colour High Density Polyethylene (HDPE)

**Recycled Profile** - Recycled plastic with textured finish

**LumbeRock Benches** - Recycled HDPE milk bottles with a wood grain finish

### SUPPLY METHOD

Carriage - Fully assembled

### FEATURES

 **SOCIAL** - Carriage seating

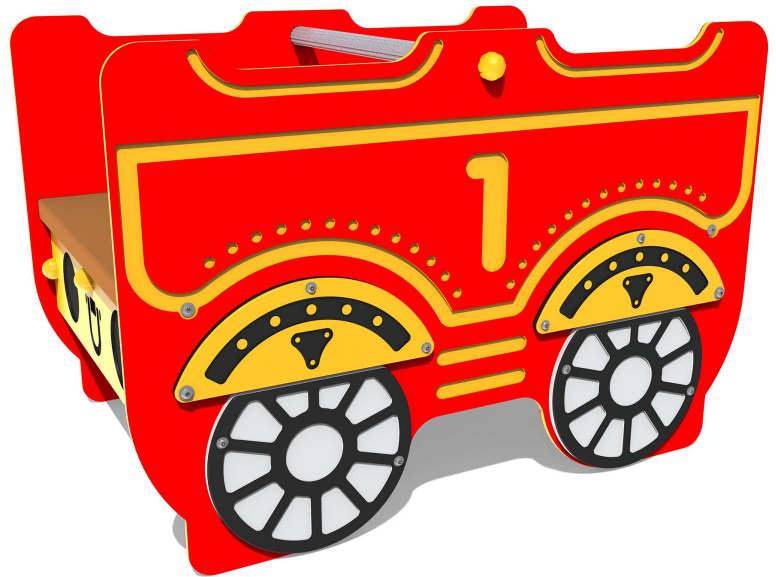

FIEXPCARR1 - Carriage 1



FIEXPCARR2 - Carriage 2



FIEXPCARR3 - Carriage 3

### DIMENSIONS

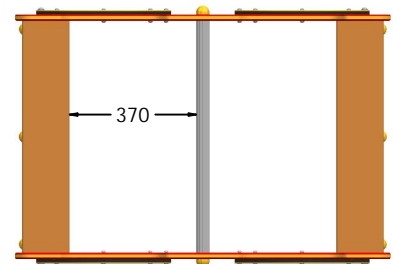
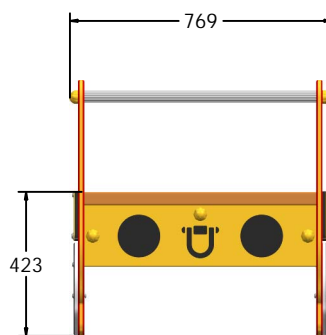
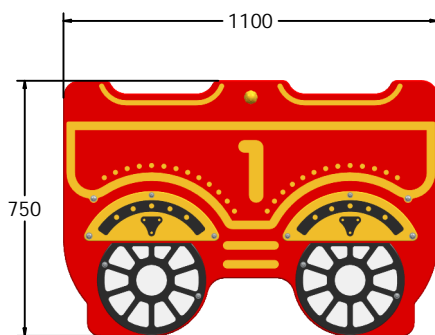

### TECHNICAL

**Age Range:** 2+ Years  
**Largest Part:** FIEXPCARR1 - 1100 x 750 x 769mm  
**Total Weight:** FIEXPCARR1 - 48kg  
**Surfacing:** N/A

IMPORTANT: you must specify the colour option you require at the time of order if it is different from the colour listed/shown above, requirements are subject to availability at the time of order