

# Product Information

## FIPTPIANOIN - PlayTronic Piano Insert

BS EN 1176 - Designed to British & European Standards



### MATERIALS

Panel - Two Colour  High Density Polyethylene (HDPE)

### SUPPLY METHOD

Insert - Fully assembled

### FEATURES

-  **MUSICAL** - 8 Different piano notes
-  **BATTERY** - Replaceable batteries
-  **INTERACTIVE** - Touch sensitive buttons

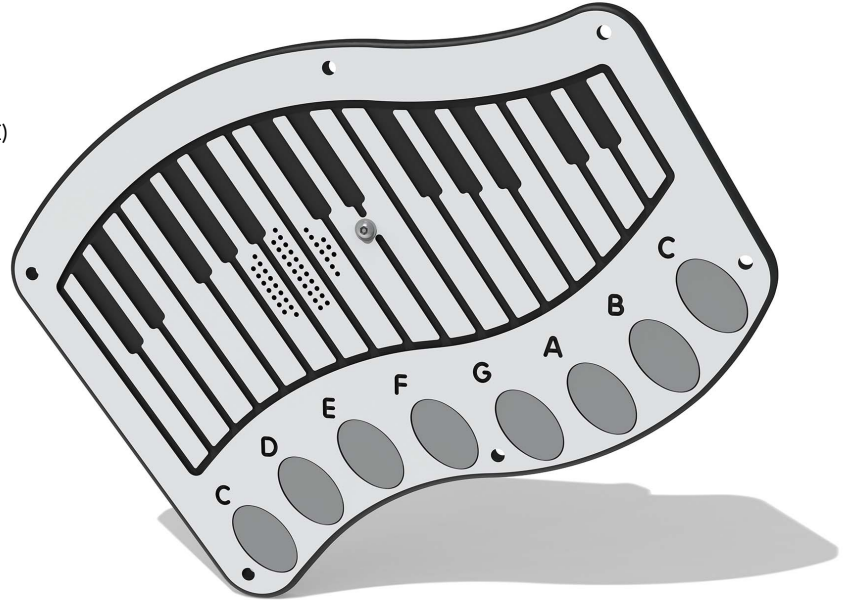

**PlayTronic**  
outdoor electronics

ELECTRONICS

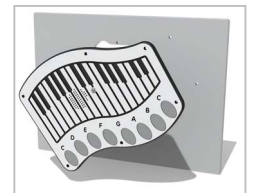

Insert can be easily attached to your own panel

### DIMENSIONS

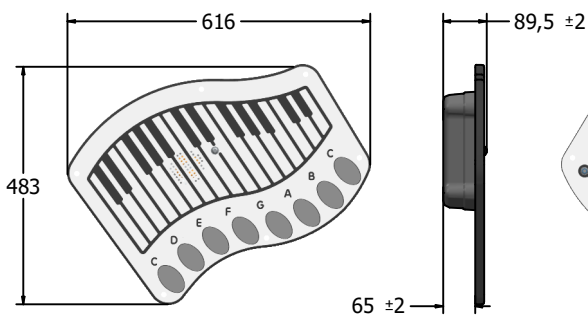

### Host Panel Fixing Detail

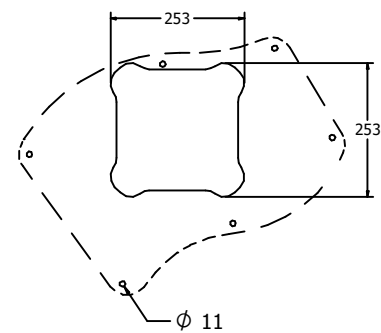

CAD Template Available

### TECHNICAL

Age Range: 2+ Years  
 Largest Part: FIPTPIANOIN - 483 x 616 x 89.5mm  
 Total Weight: FIPTPIANOIN - 4.6kg  
 Surfacing: N/A

IMPORTANT: you must specify the colour option you require at the time of order if it is different from the colour listed/shown above, requirements are subject to availability at the time of order