

# Product Information

## FIFMTRACT - Terry the Tractor

BS EN 1176 - Designed to British & European Standards

### MATERIALS

**Panels** - Two Colour High Density Polyethylene (HDPE)





**Recycled Profile** - Recycled plastic with textured finish

**LumbeRock Benches** - Recycled HDPE milk bottles with a wood grain finish

### SUPPLY METHOD

Tractor - Fully assembled

### FEATURES

-  **SOUNDS** - Can have tractor and farm sounds
-  **BATTERY** - Can be Battery powered
-  **ROTATE** - Spinning car wheel
-  **TUNNEL** - Ribbed Crawl Through Play Tunnel

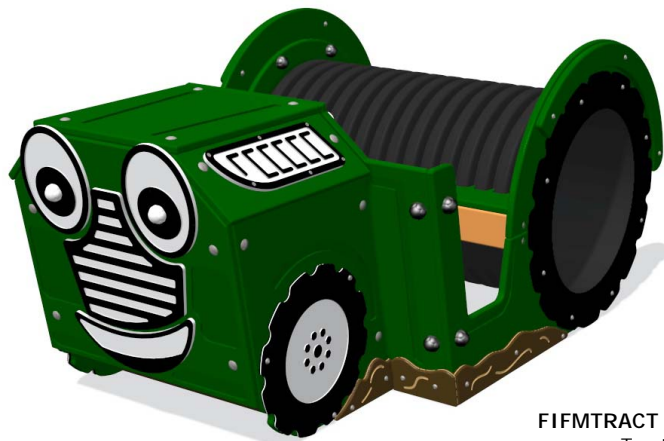

FIFMTRACT - Terry The Tractor

FIFMTRACTPT - Terry The Tractor with PlayTronic Sounds



**PlayTronic**  
outdoor electronics

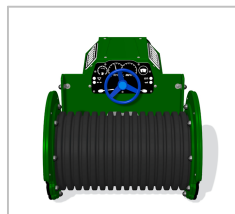

Crawl through tunnel section



Dashboard with steering wheel

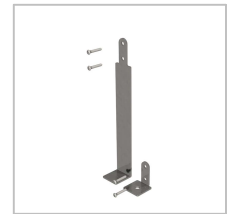

Surface or below ground fixing brackets available as an additional extra

### DIMENSIONS

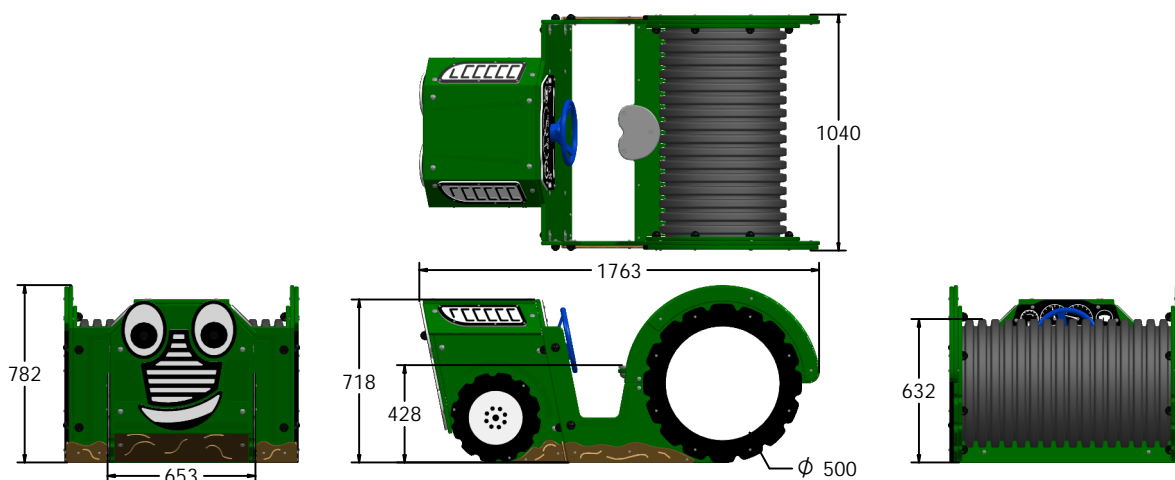

### TECHNICAL

Age Range:	2+ Years
Largest Part:	Tractor Assembly - 1763 x 782 x 1040mm
Total Weight:	120kg Approx
FFH (Free Fall Height):	718mm
Surfacing:	1.5m from extents of equipment

IMPORTANT: you must specify the colour option you require at the time of order if it is different from the colour listed/shown above, requirements are subject to availability at the time of order