

Product Information

FIFMTRACT - Terry the Tractor

BS EN 1176 - Designed to British & European Standards

MATERIALS

Panels - Two Colour High Density Polyethylene (HDPE)

Recycled Profile - Recycled plastic with textured finish

LumbeRock Benches - Recycled HDPE milk bottles with a wood grain finish

SUPPLY METHOD

Tractor - Fully assembled

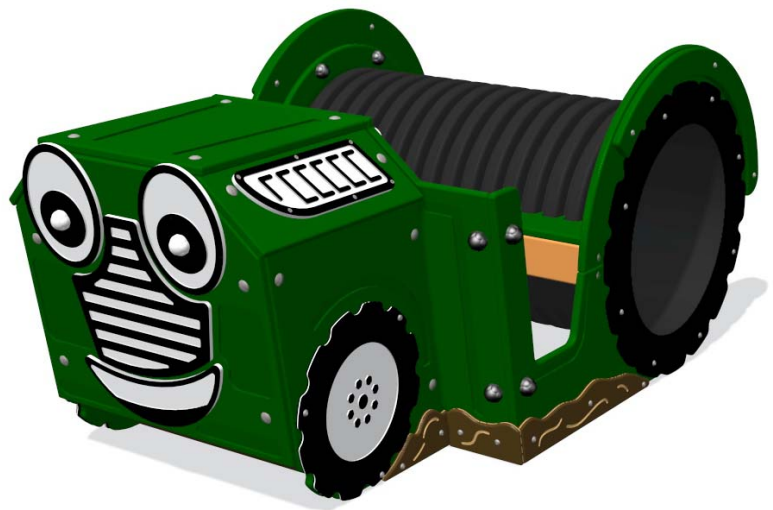

FIFMTRACT - Terry The Tractor

FIFMTRACTPT - Terry The Tractor with PlayTronic Dashboard

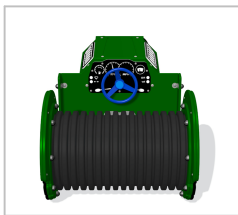

Crawl through tunnel section



Dashboard with steering wheel

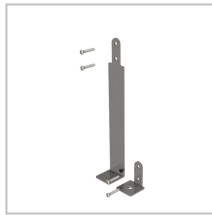

Surface or below ground fixing brackets available as an additional extra

DIMENSIONS

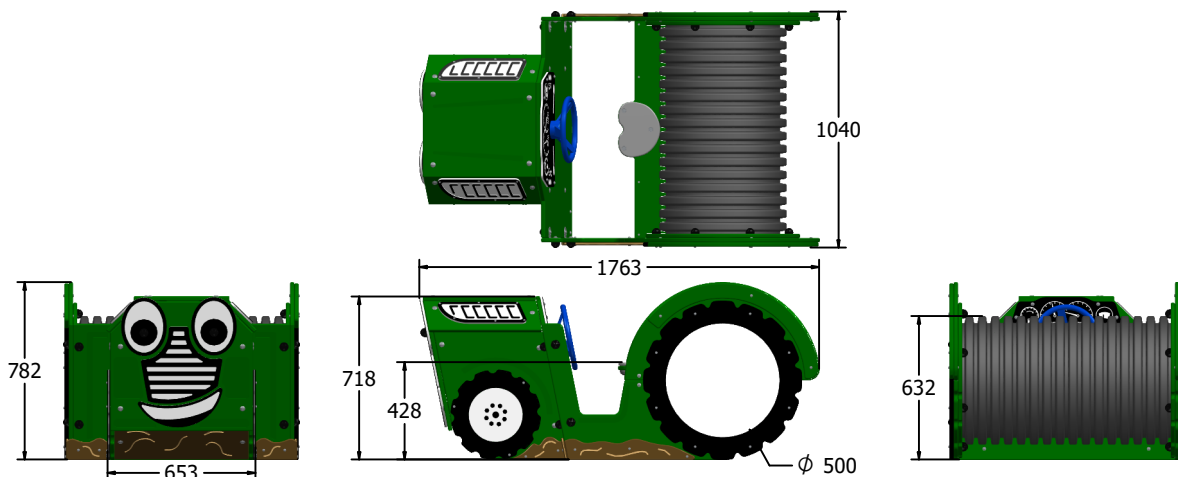

TECHNICAL

Age Range:	2+ Years
Largest Part:	Tractor Assembly - 1763 x 1040 x 782mm
Total Weight:	120kg Approx
FFH (Free Fall Height):	718mm
Surfacing:	1.5m from extents of equipment

IMPORTANT: you must specify the colour option you require at the time of order if it is different from the colour listed/shown above, requirements are subject to availability at the time of order

Product Information

FIFMTRAIL - Tractor Activity Trailer

BS EN 1176 - Designed to British & European Standards

MATERIALS

Panels - Two Colour High Density Polyethylene (HDPE)

Recycled Plastic Support - Recycled plastic with textured finish

SUPPLY METHOD

Train - Fully assembled

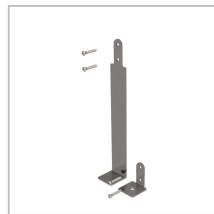
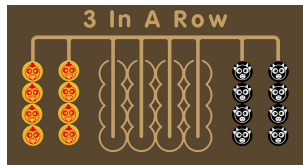
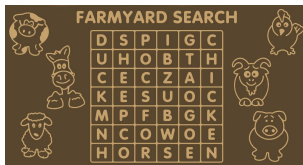
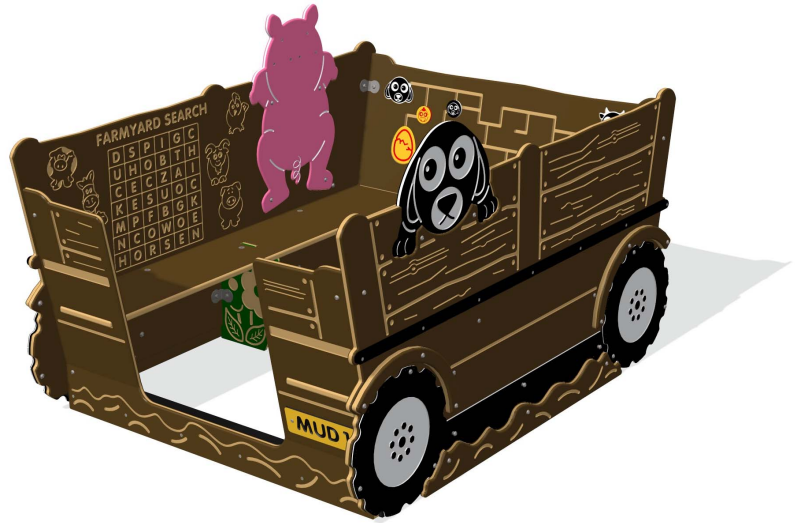

Surface or below ground fixing brackets available as an additional extra



3 interactive games inside

DIMENSIONS

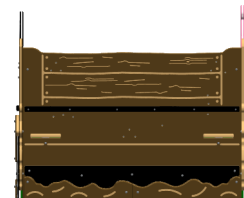
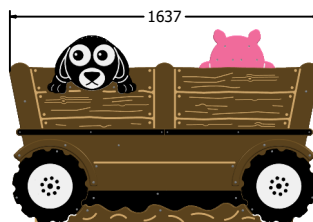
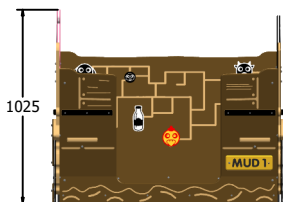

TECHNICAL

Age Range:	2+ Years
Largest Part:	Trailer Assembly - 1637 x 1241 x 1025mm
Total Weight:	108kg Approx
FFH (Free Fall Height):	350mm
Surfacing:	N/A

IMPORTANT: you must specify the colour option you require at the time of order if it is different from the colour listed/shown above, requirements are subject to availability at the time of order